

CENTER AIRBAG SENSOR ASSEMBLY

COMPONENTS

RS

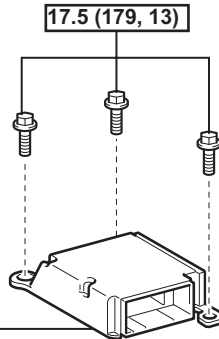

CENTER AIRBAG SENSOR ASSEMBLY

for Automatic Transaxle (2WD):

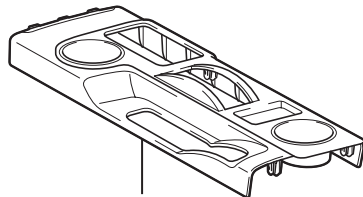

CONSOLE UPPER REAR PANEL SUB-ASSEMBLY

for Automatic Transaxle (4WD):

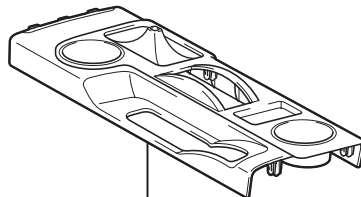
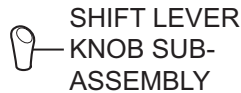

CONSOLE UPPER REAR PANEL SUB-ASSEMBLY

for Manual Transaxle:

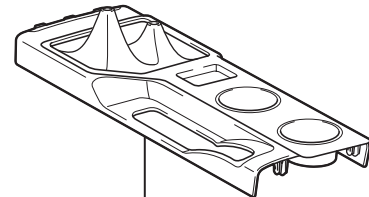
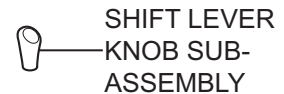

CONSOLE UPPER REAR PANEL SUB-ASSEMBLY



PARKING BRAKE HOLE COVER SUB-ASSEMBLY

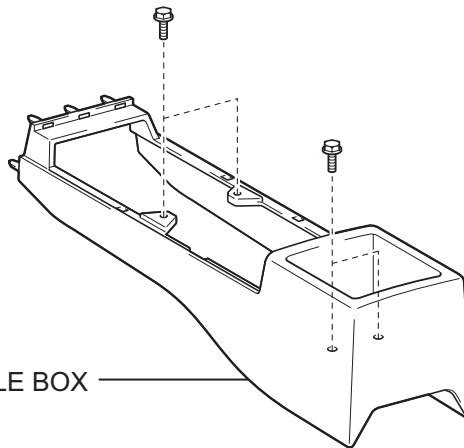

FRONT CONSOLE BOX

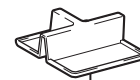

BOX BOTTOM MAT

N*m (kgf*cm, ft.*lbf): Specified torque

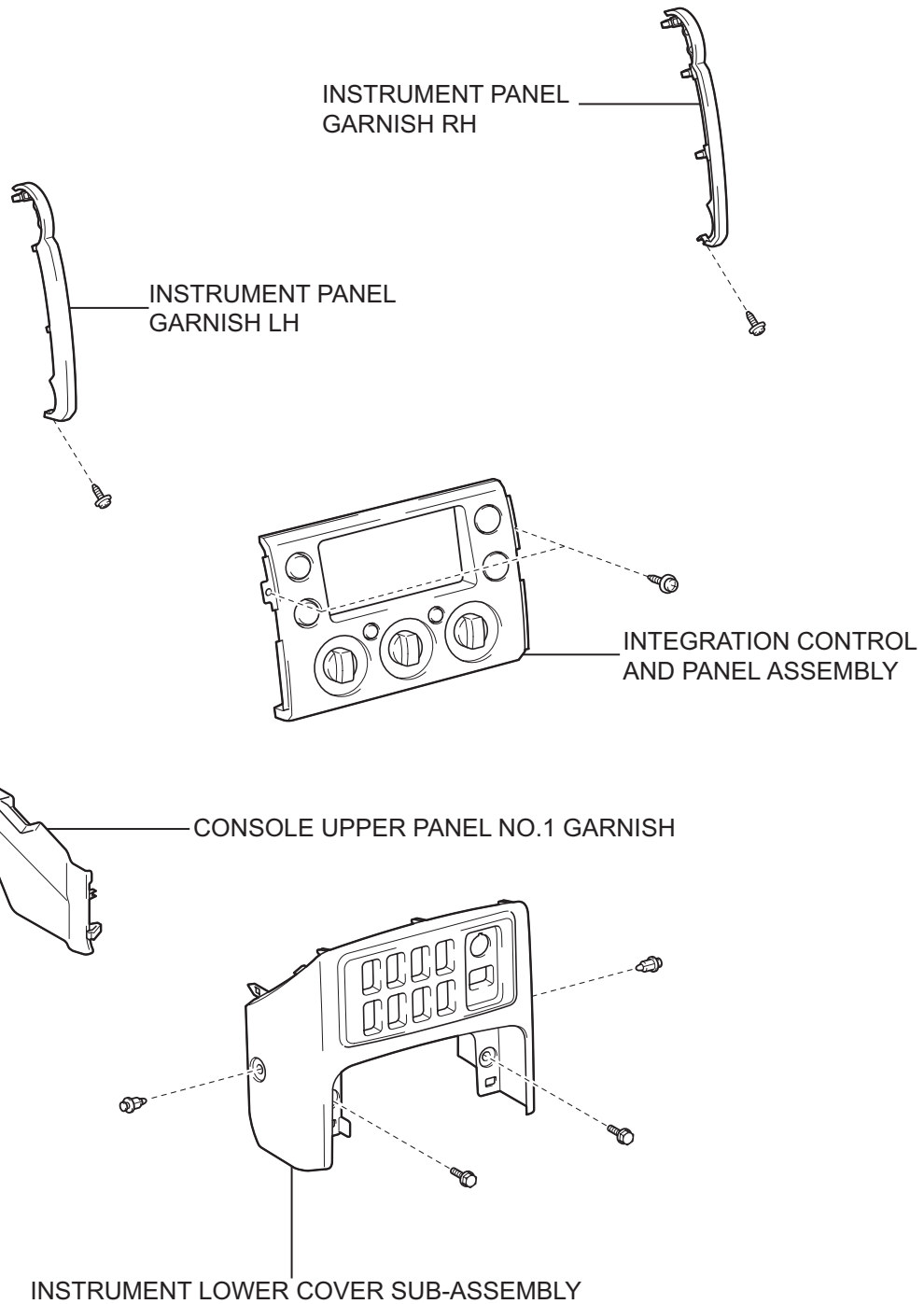

RS